

Lid Bed Collection

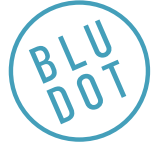

DESIGNED IN 2017

ASSEMBLY NOTES | REV 03

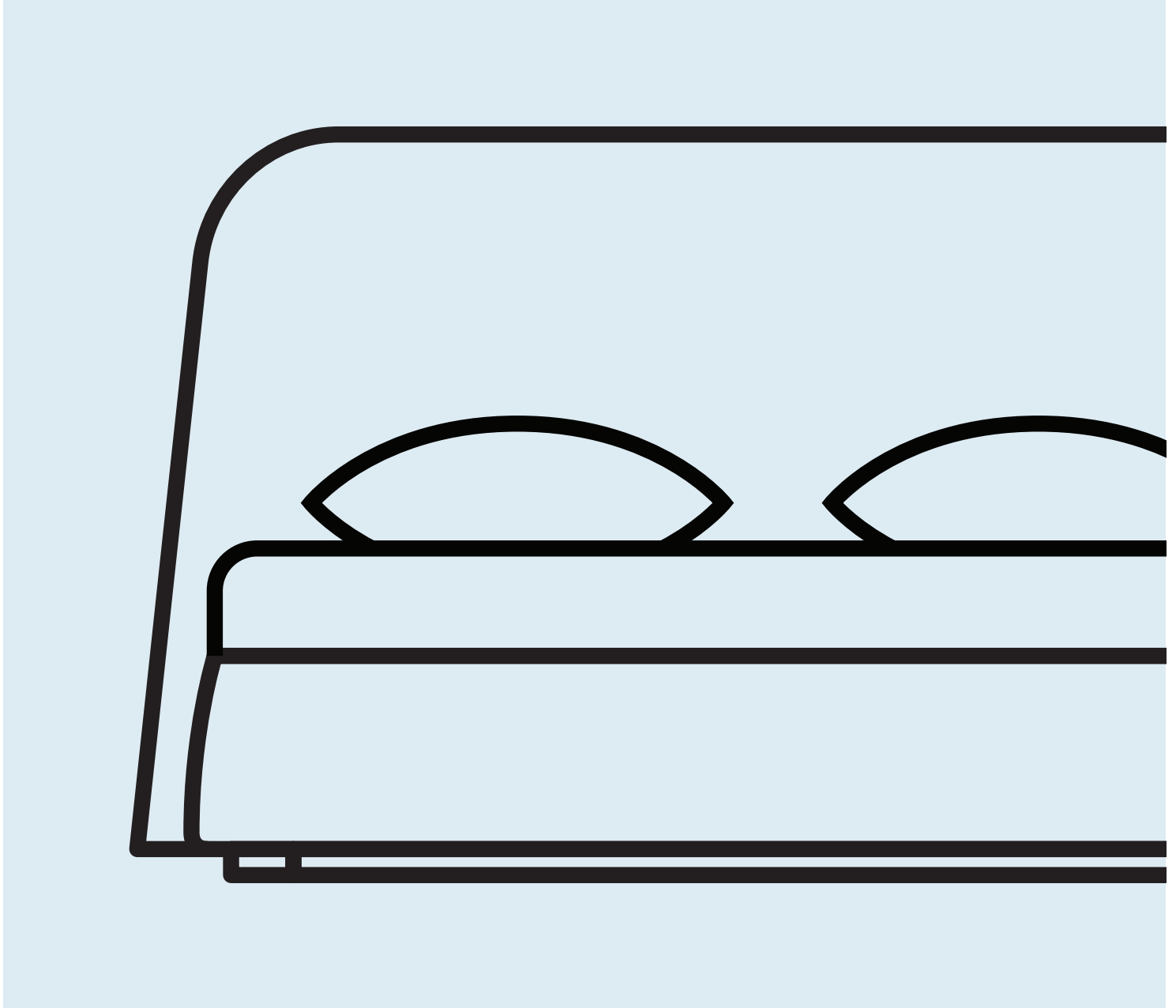

NO WRONG SIDE HERE.

Sleep well knowing that you are on top of your storage. Literally. The Lid Storage bed provides an inconspicuous spot for whatever needs to be stashed below.

NEED A HAND?

Contact us at service@bludot.com or **844.425.8368** for assistance.

Parts & Hardware

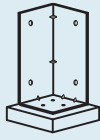

QTY 4

Foot



QTY 2*

Center Foot



QTY 8*

Pt. 8050

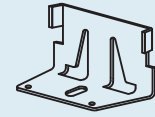

QTY 2*

Pt. 8051

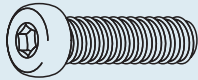

M8 x 45mm

QTY 8

Pt. 1099

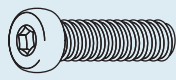

M8 x 20mm

QTY 20

Pt. 1101

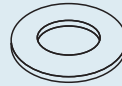

QTY 28

Pt. 3007

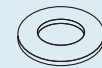

QTY 2

Pt. 3002



M6 x 40mm

QTY 4*

Pt. 1102

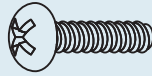

M6 x 20mm

QTY 6*

Pt. 1103



QTY 1

Pt. 9022

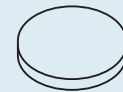

QTY 4

Pt. 4007

* Twin Bed does not include center legs or center rail. Noted hardware quantities will be less to match. Feel free to contact customer service with hardware questions for your particular product.

Parts & Hardware

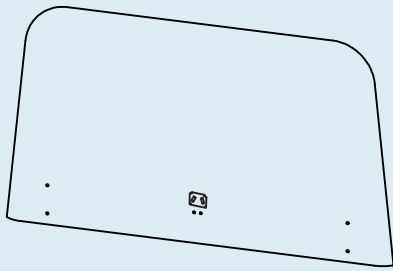

QTY 1*
Headboard

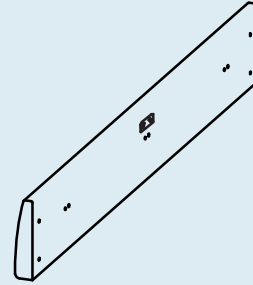

QTY 1*
Footboard

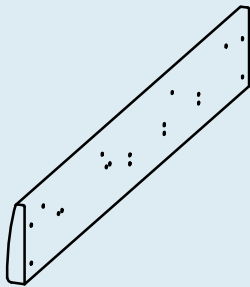

QTY 1
Left Side Rail

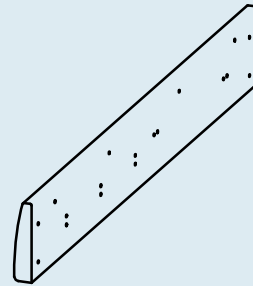

QTY 1
Right Side Rail

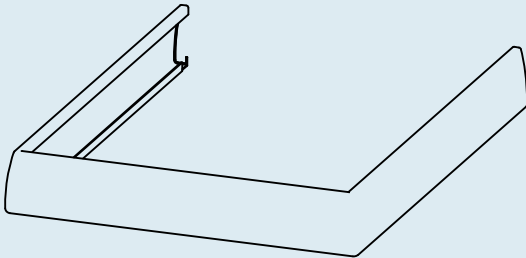

QTY 1
Slip Cover

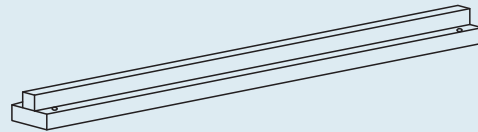

QTY 1**
Center Rail

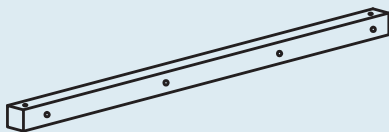

QTY 2
Slat Support

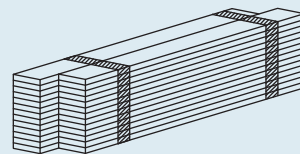

QTY 2**
Slat

* Platform storage bed ships with x2 footboards.

** Twin bed ships with x1 slat roll and no center rail.

Step 01

ATTACHING THE FEET.

Begin by attaching the round adhesive pads to the feet. Attach the feet to the side rails as shown using the provided hardware.

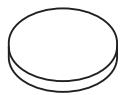
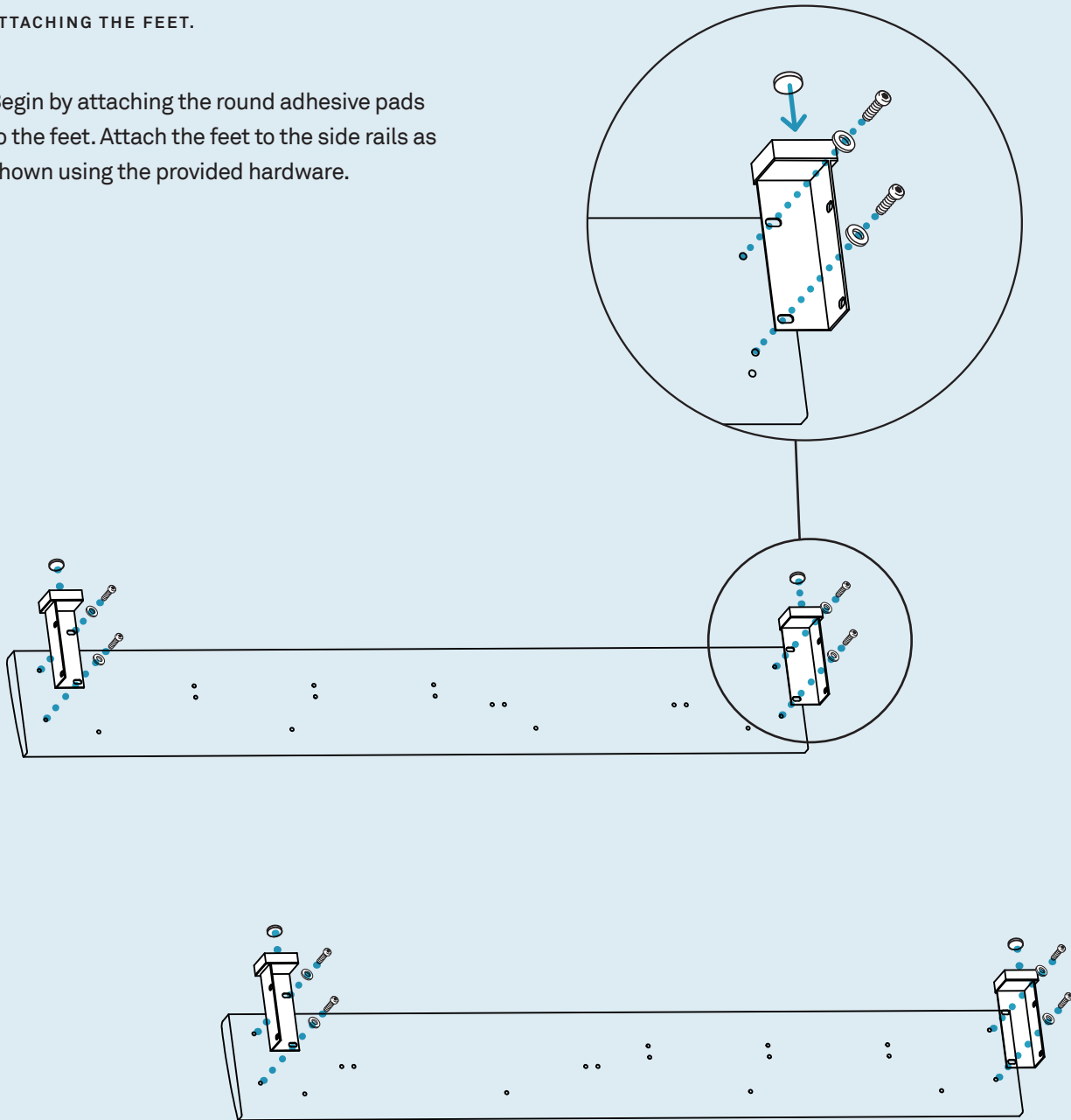

PT. 4007 x 4

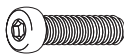

PT. 1101 x 8

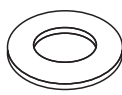

PT. 3007 x 8



PT. 9022 x 1

Step 02

ATTACHING THE FOOTBOARD.

Attach the footboard to the side rails using the provided hardware as shown.

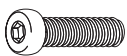
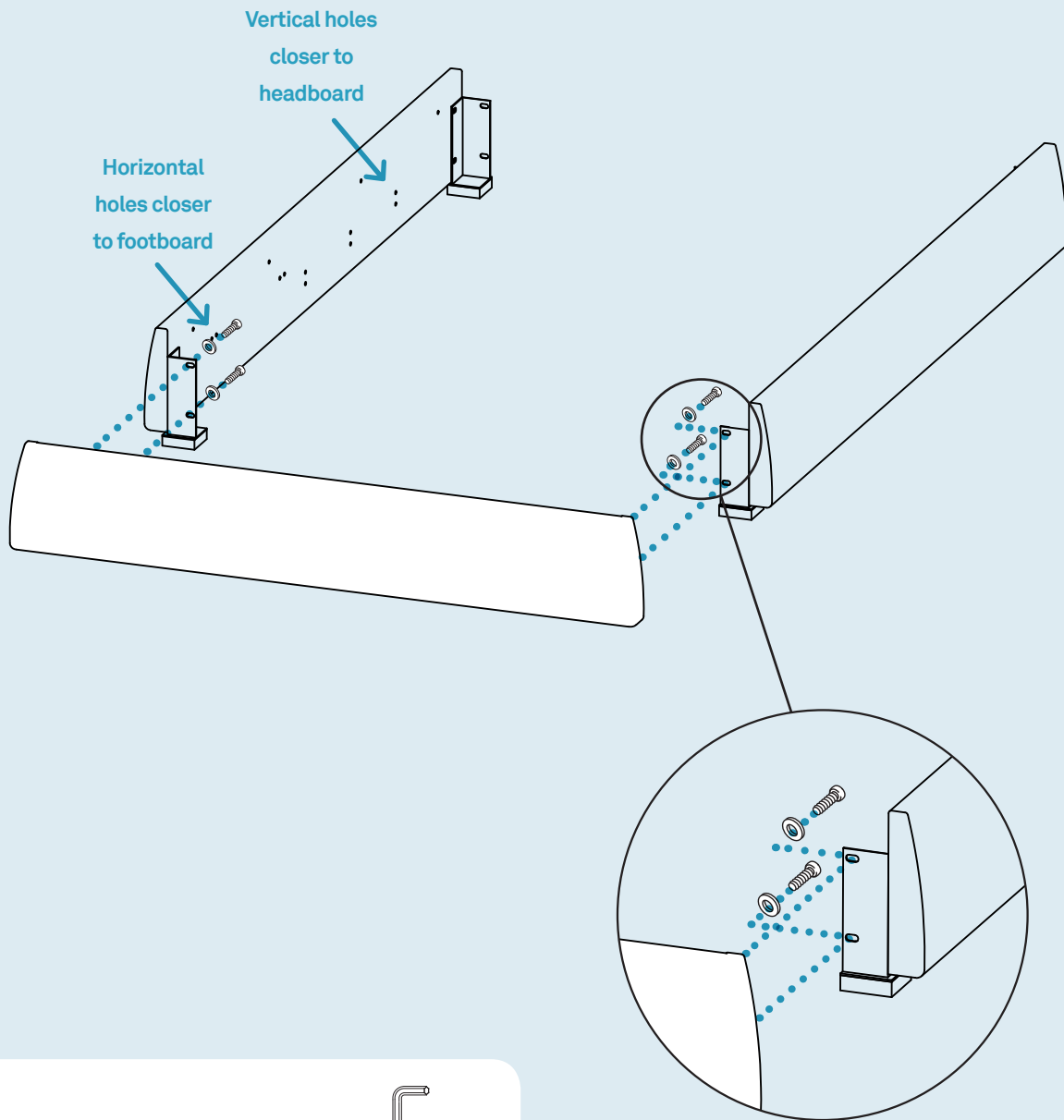

PT. 1101 x 4

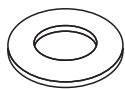

PT. 3007 x 4

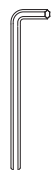

PT. 9022 x 1

Step 03

ATTACHING THE HEADBOARD.

With the help of a second person, align the headboard bolt holes with the foot bracket holes. Attach as shown using the provided hardware.

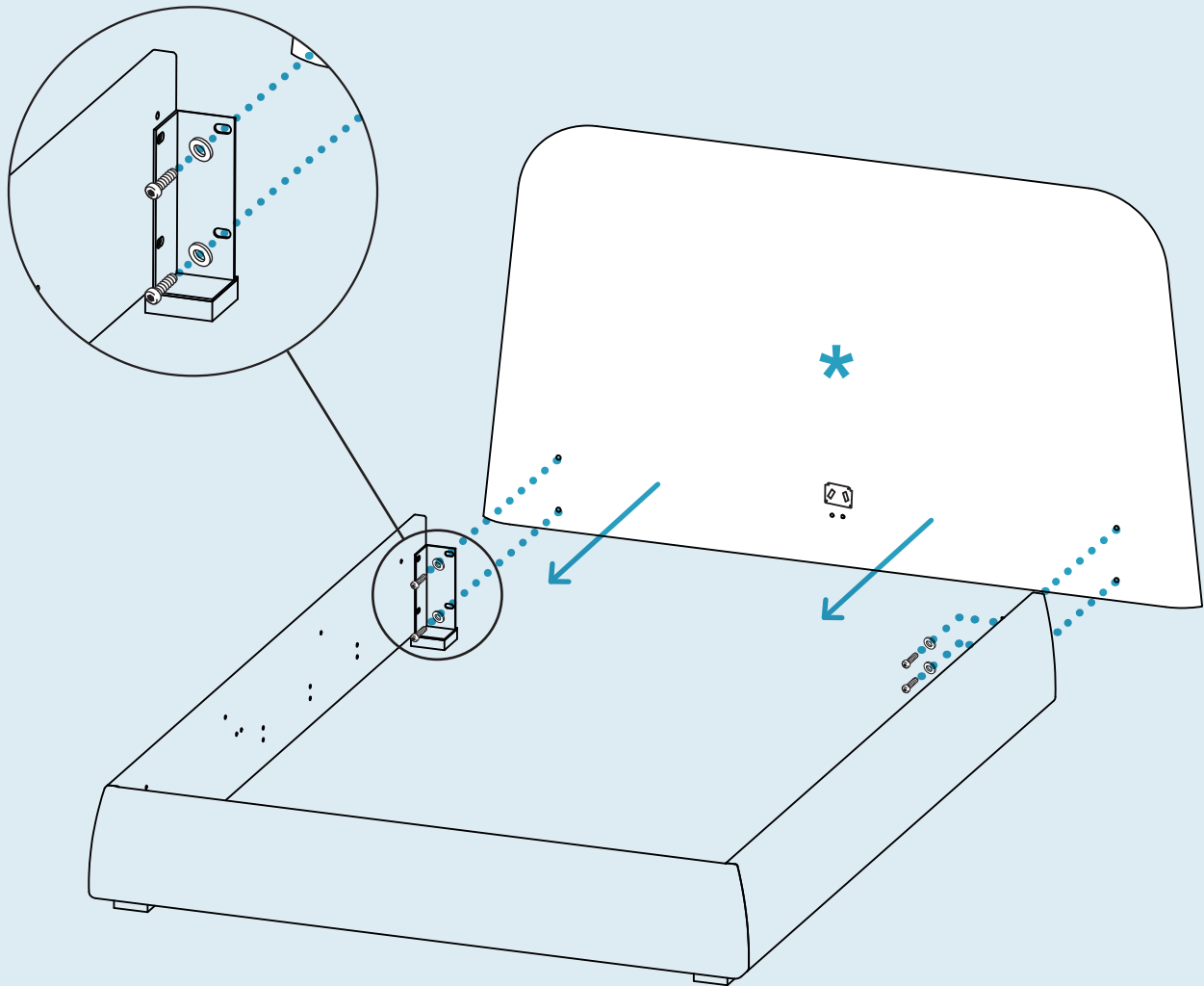

* Platform storage bed ships with two footboards.
Attachment points are the same as shown.

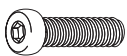

PT. 1101 x 4

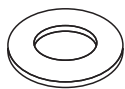

PT. 3007 x 4



PT. 9022 x 1

Step 04

INSTALLING THE SLIP COVER.

Begin attaching the slip cover at the inner footboard corners and work up to the headboard. Wrap the slip cover around the frame and attach at the bottom using the velco strips.

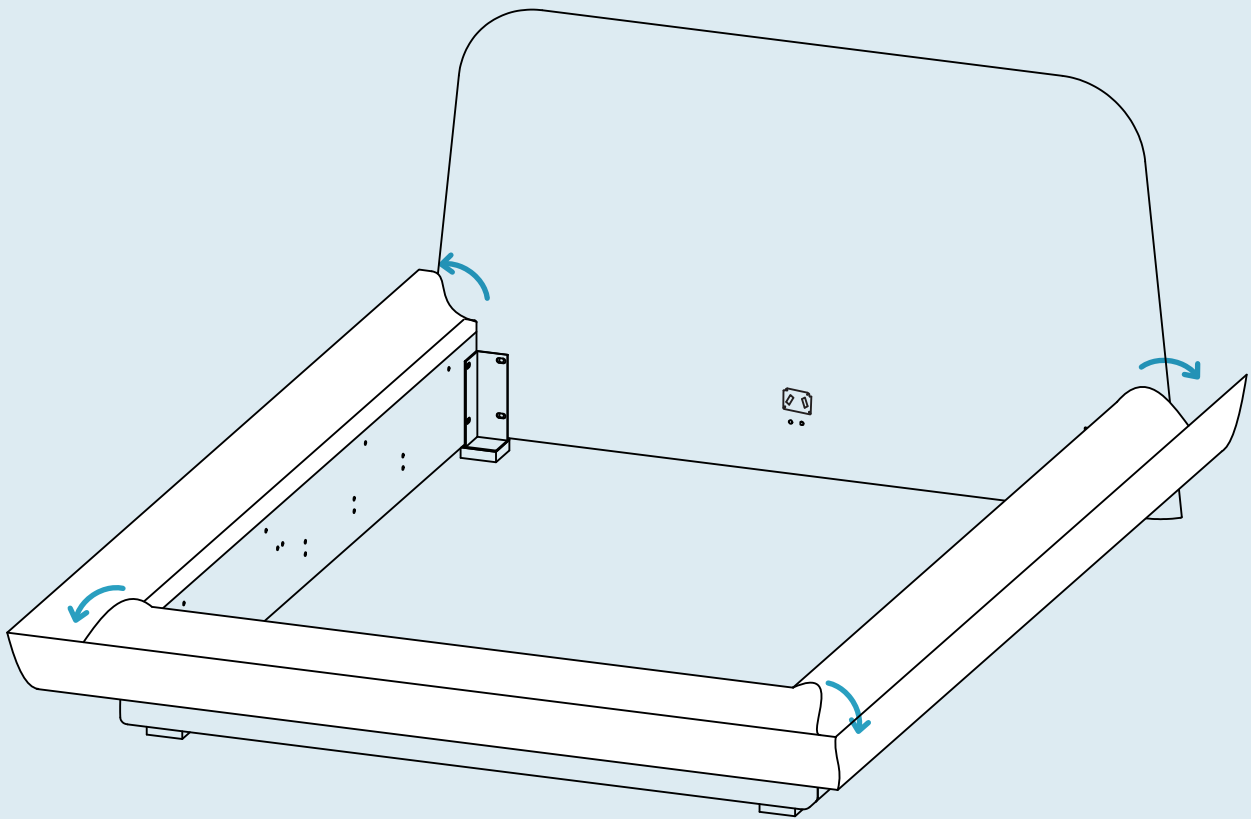

Step 05

ASSEMBLING THE SLAT SUPPORTS.

Using a phillips head screwdriver, assemble the slat supports as shown using the provided hardware. Repeat for the remaining slat support.

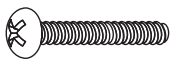
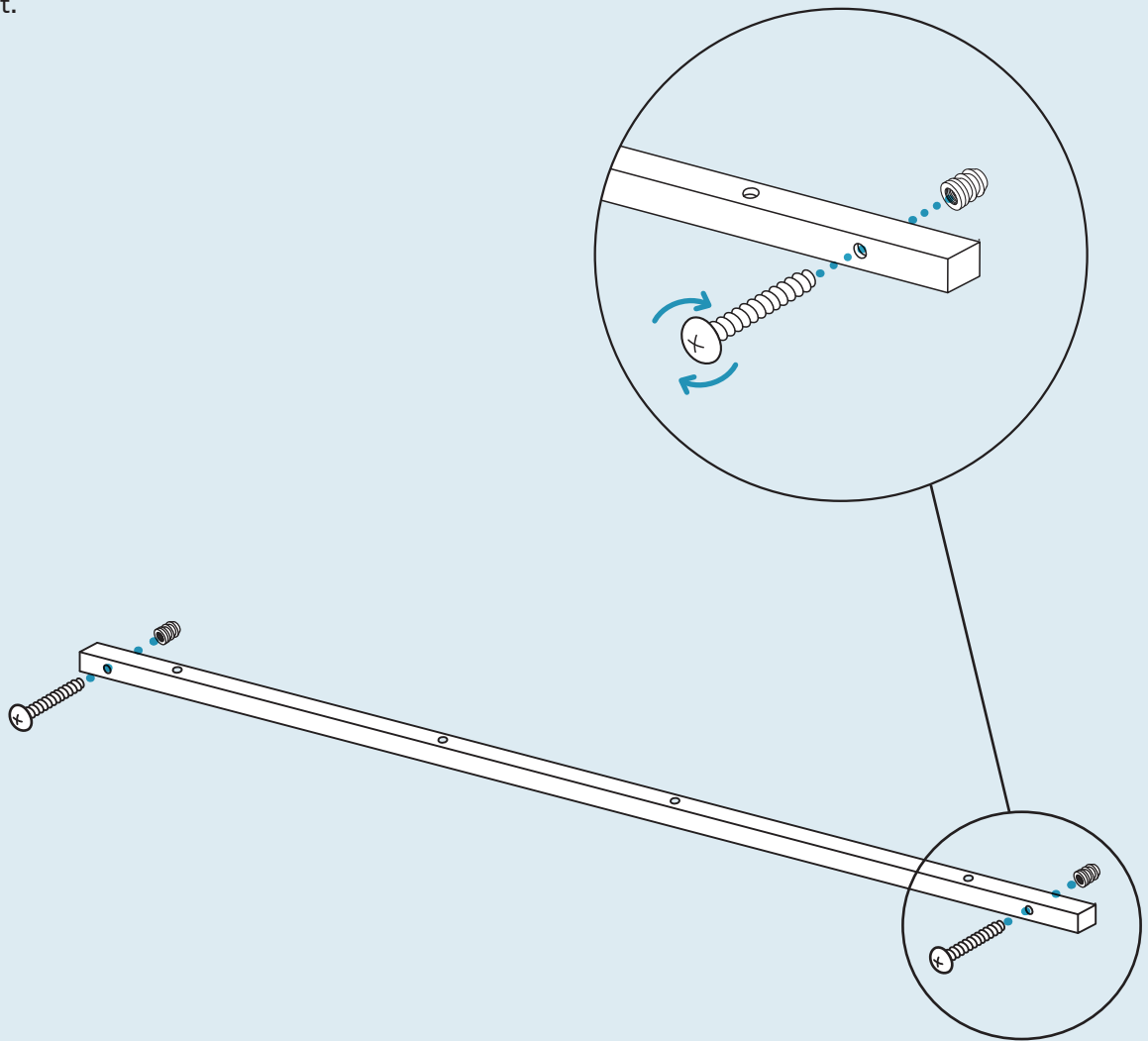

PT. 1102 x 4



PT. 8050 x 4

Step 06

ATTACHING THE SLAT SUPPORTS.

Attach the slat supports to the side rails as shown using the provided hardware.

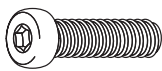
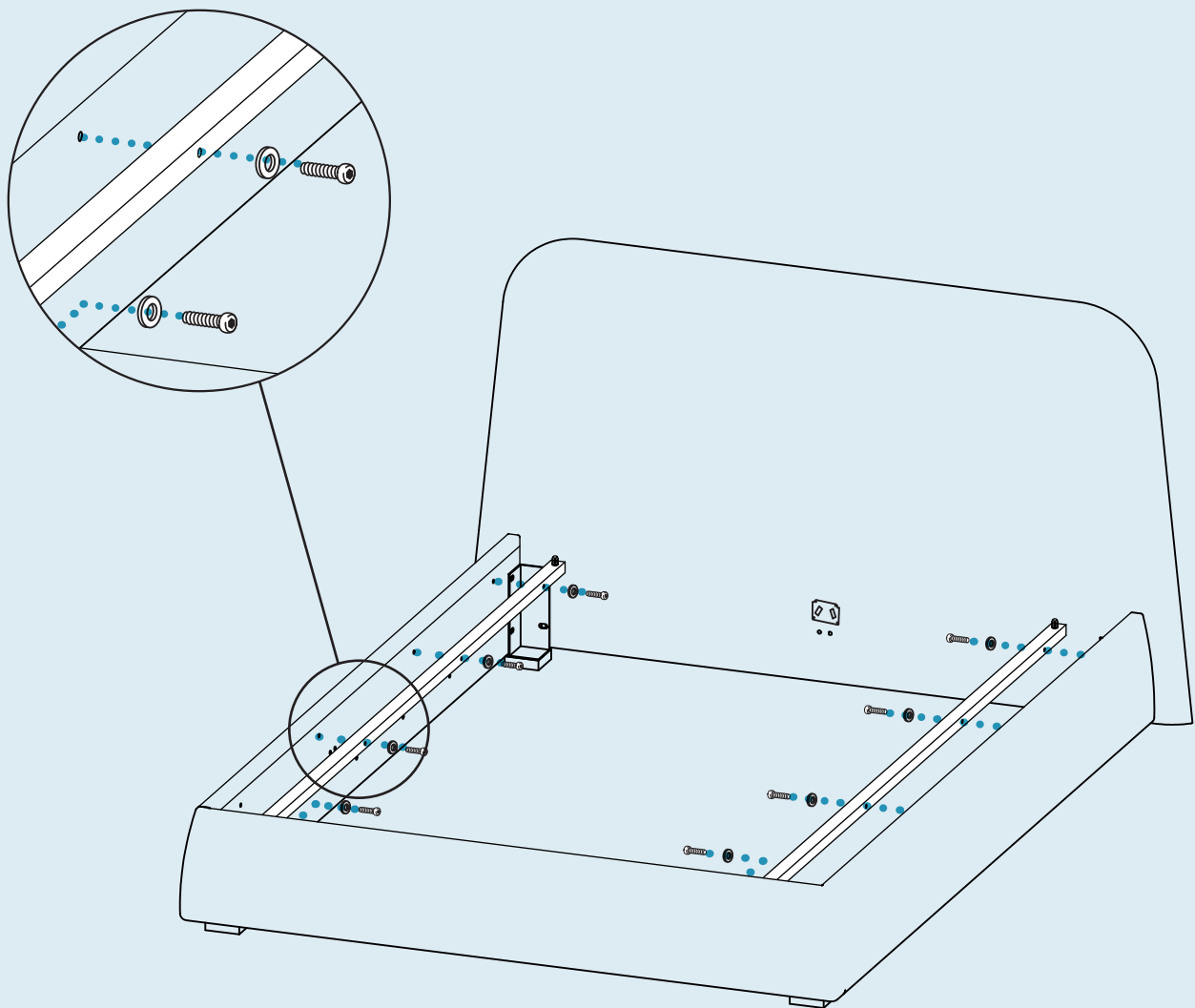

PT. 1099 x 8

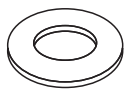

PT. 3007 x 8



PT. 9022 x 1

Step 07

ASSEMBLING THE CENTER RAIL, IF INCLUDED.

If assembling a twin bed, please move to Step 09.
If a center rail is included, please follow the below step.

Position the center rail on a soft surface and connect the product pieces as shown using the provided hardware.

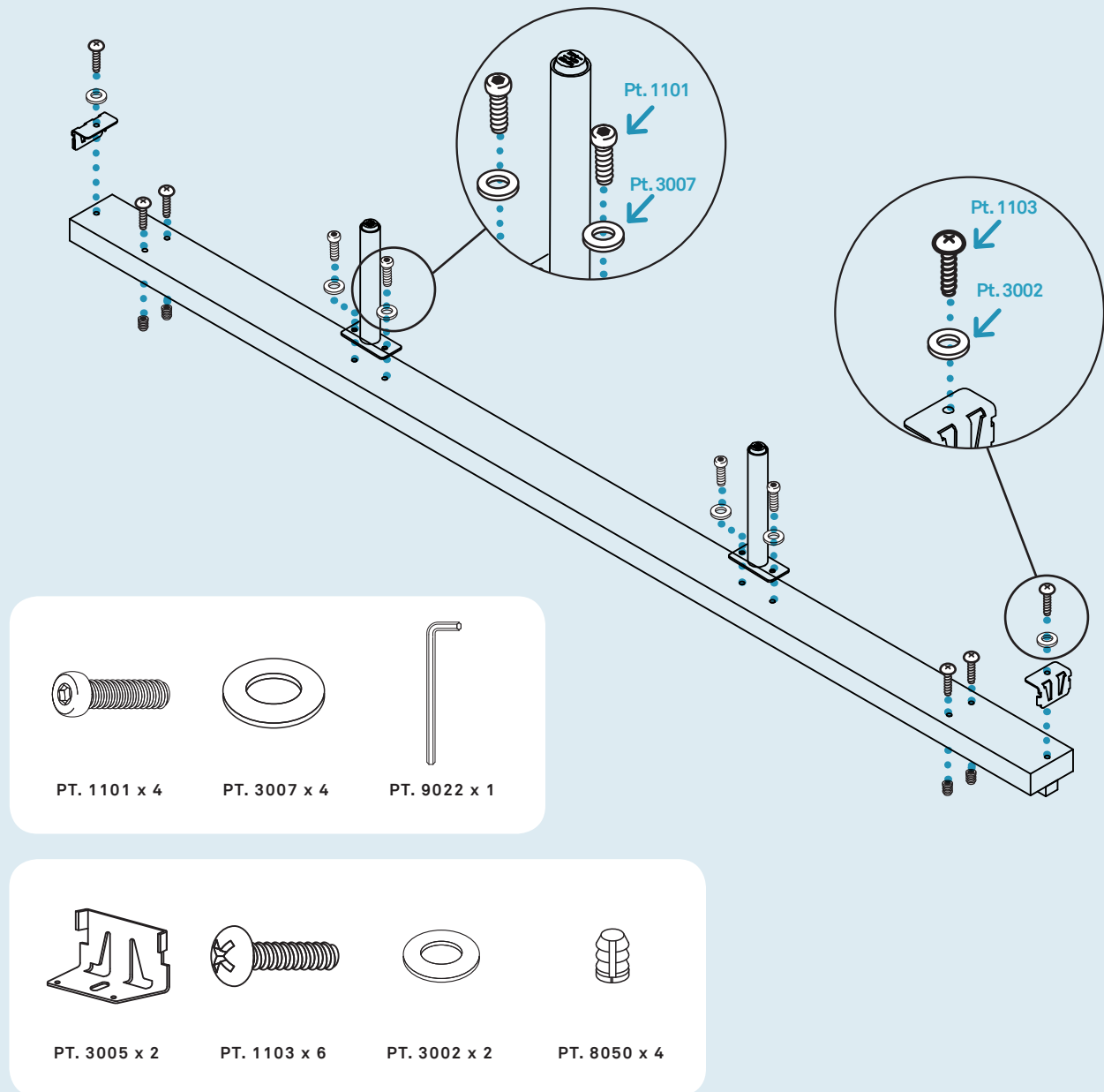

Step 08

ATTACHING THE CENTER RAIL, IF INCLUDED

If assembling a twin bed, please move to Step 09.
If a center rail is included, please follow the below step.

With the help of a second person, align the metal brackets on the center rail with the pre-attached brackets on the head and footboards.

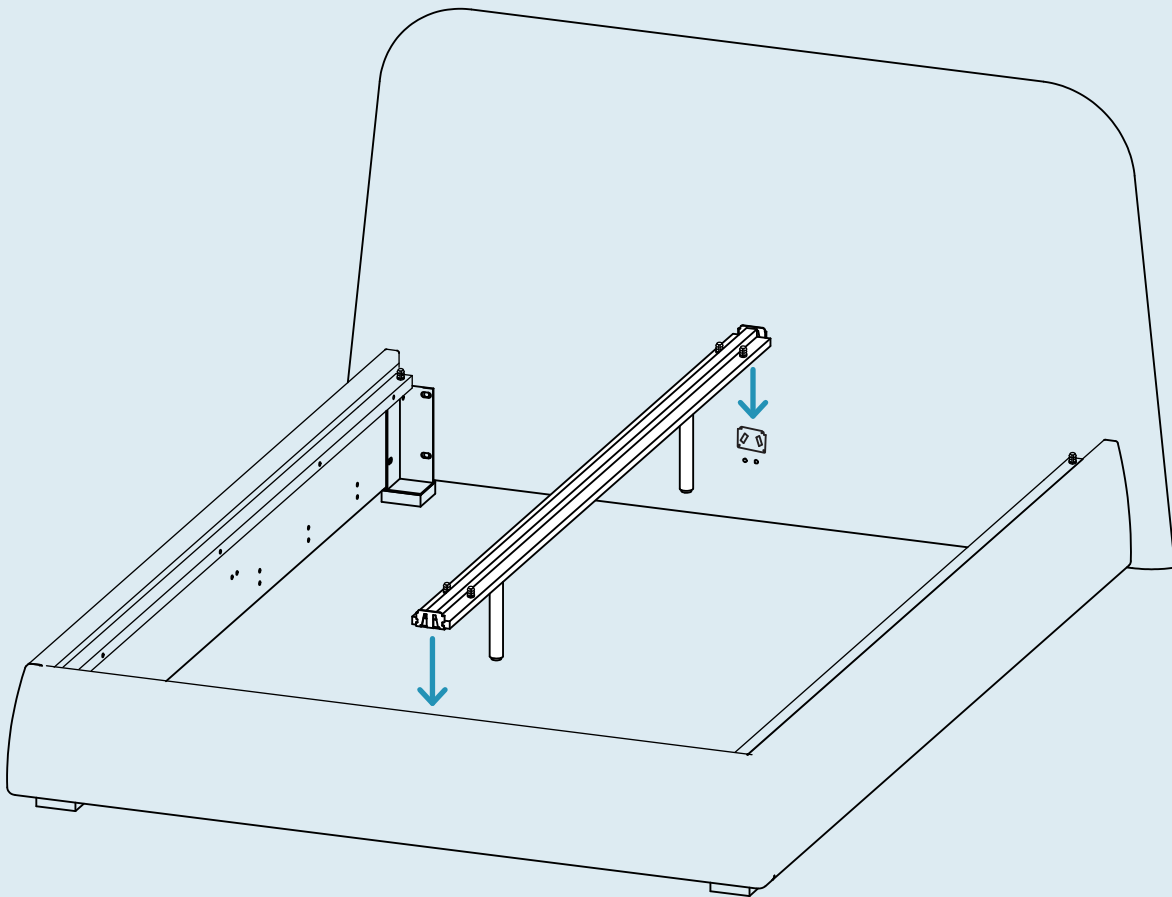

Step 09

ATTACHING THE SLATS.

Starting at the headboard, install slats as shown.

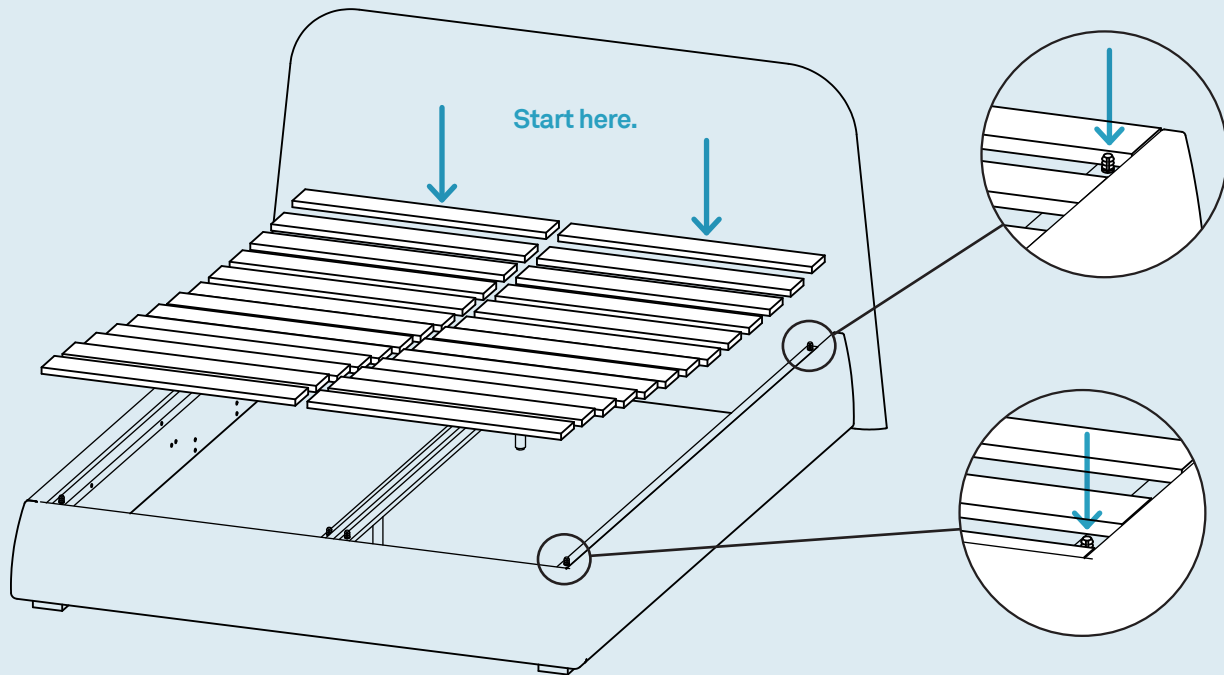

Additional Information

CLEAN

Vacuum your upholstery regularly. For leather furniture dust regularly with a dry cloth.

SPILLS

Act quickly with spills. Absorb the spill with a clean white cloth or paper towel. Never rub the surface. Do not use water or other liquids to clean, as they may cause stains. Consult a commercial cleaning specialist for removal of stubborn stains.

AVOID

Keep furniture out of direct sunlight and away from heat sources; excessive exposure to sunlight may cause color fading. Avoid placing heavy or sharp objects on the furniture surface for long periods of time; this can cause permanent surface indentations. For snags in the fabric, tuck loose threads into fabric or carefully push to reverse side. Never pull out or cut off loose threads.

